

McIntosh
MC 2100

OWNER'S MANUAL

THE McINTOSH MC 2100 SOLID STATE STEREO POWER AMPLIFIER



Price \$1.25

Your MC 2100 stereo amplifier will give you many years of pleasant and satisfactory performance. If you have any questions concerning operation or maintenance please contact the dealer from whom you purchased this instrument or:—

CUSTOMER SERVICE

McIntosh Laboratory Inc.
2 Chambers Street
Binghamton, New York 13903
Phone: 607-723-3512

**Take Advantage of 3 years
of FREE Factory Service ...
Fill in the Application NOW.**

CONTENTS

GUARANTEE . . .	1
INSTALLATION . . .	2
HOW TO CONNECT . . .	2, 3
CONTROL PANEL INFORMATION . . .	4
LISTENING TO YOUR STEREO SYSTEM . . .	5
PERFORMANCE LIMITS . . .	5
PERFORMANCE CHARTS . . .	6
TECHNICAL DESCRIPTION . . .	7
BLOCK DIAGRAM . . .	8

GUARANTEE

McIntosh Laboratory Incorporated guarantees this Instrument to be capable of performance as advertised. We also guarantee the mechanical and electrical workmanship and components to be free of defects for a period of 90 days from date of purchase. If such defects occur, McIntosh Laboratory

or one of its authorized agencies will repair the defect at no cost to the purchaser. This guarantee does not extend to components damaged by improper use nor does it extend to transportation to and from the factory or service agency.

THREE YEAR FACTORY SERVICE CONTRACT

An application for a FREE THREE YEAR FACTORY SERVICE CONTRACT is included with this manual. The terms of the contract are:

For Three Years from date of purchase —

1. McIntosh will provide all parts, materials and labor needed to return the measured performance of the instrument to the original performance limits free of any charge. The SERVICE CONTRACT does not cover any shipping costs to and from the authorized service agency or the factory.
2. Any McIntosh authorized service agency will repair all McIntosh instruments at normal service rates. To receive the free service under the terms of the SERVICE CONTRACT, the SERVICE CONTRACT CERTIFICATE must accompany the instrument when taken to the service agency.
3. Always have service done by a McIntosh authorized service agency. If the instrument is modified or damaged, as a result of unauthorized repair the SERVICE CONTRACT will be cancelled. Damage by improper use or mishandling is not covered by the SERVICE CONTRACT.

4. The SERVICE CONTRACT is issued to you as the original purchaser. To protect you from misrepresentation this contract cannot be transferred to a second owner.
5. The SERVICE CONTRACT is given to purchasers who live in the 50 United States or Canada only.
6. For your protection McIntosh selects its dealers carefully. Only one dealer in ten qualifies for a McIntosh franchise. To receive the SERVICE CONTRACT your purchase must be made from a McIntosh franchised dealer.
7. Your completely filled in application for a SERVICE CONTRACT must be postmarked within 30 days of the date of purchase of the instrument.
8. To receive the SERVICE CONTRACT all information on the application must be filled in. The SERVICE CONTRACT will be issued when the completely filled in application is received at McIntosh Laboratory Incorporated in Binghamton, New York. If the application is not received at McIntosh Laboratory, only the service offered under the 90-day guarantee will apply.

INSTALLATION

Adequate ventilation extends the trouble-free life of electronic instruments. It is generally found that each 10° centigrade (18° F) rise in temperature reduces the life of electrical insulation by one half. Adequate ventilation is an inexpensive and effective means of preventing insulation breakdown that results from unnecessarily high operating temperatures. The direct benefit of adequate ventilation is longer, trouble-free life.

The suggested minimum space for mounting the MC2100 is 20 inches deep x 9½ inches high x 12 inches wide. Always allow for air flow by either ventilation holes or space next to the bottom of the amplifier and a means for the warm air to escape at the top.

It is recommended that the MC2100 be mounted in a normal or horizontal position. However with adequate ventilation, the amplifier can be mounted in any position except upside down. If the amplifier is to be installed on a vertical surface it is recommended that the autotransformers be on the down side. This position permits greater air flow around the transistors and component parts thereby extending the trouble-free life of the amplifier.

HOW TO CONNECT

INPUT-STEREO

The shielded cable from the left output of the McIntosh preamplifier is plugged into the left jack. The shielded cable from the right output of the McIntosh preamplifier is plugged into the right jack. The INPUT switch must be in the STEREO position and the OUTPUT properly connected to the stereo loudspeakers or distortion and loss of power may result.

INPUT-MONO

The shielded cable from the program source is plugged into the right jack. The INPUT switch must be in the MONO position and the OUTPUT properly connected for mono loudspeaker operation or distortion and loss of power may result.

OUTPUT-STEREO OR TWIN AMPLIFIERS

For stereo or twin channel operation it is not necessary to use the same impedance loudspeaker on each output. Simply connect each channel for the impedance desired.

SPEAKERS

Speakers are connected at the barrier strips marked OUTPUT on the sloped panel of the amplifier. Use lamp cord, bell wire, or wire with similar type of insulation to connect the speakers to the amplifier. For the normally short distances of under 50 feet between the amplifier and speaker, #18 wire or larger can be used. For distances over 50 feet between the amplifier and speaker use larger wire.

The loudspeaker impedance is usually identified on the loudspeaker itself. Connect one of the leads from the left loudspeaker to the screw marked COM on the LEFT OUTPUT barrier strip. Connect the other lead from the left loudspeaker to the screw marked with the number corresponding to the speaker impedance on the LEFT OUTPUT barrier strip. Connect one of the leads from the right loudspeaker to the screw marked COM on the RIGHT OUTPUT barrier strip. Connect the other lead from the right loudspeaker to the screw marked with the number corresponding to the speaker impedance on the RIGHT OUTPUT barrier strip.

The only adverse effect on the operation of a McIntosh amplifier when it is improperly matched is a reduction in the amount of distortion-free power available to the loudspeaker. Close impedance matching is desirable for maximum distortion-free power.

SPEAKER CONNECTIONS

Use this table to determine proper speaker connection:

If the speaker impedance is between:	Connect the speaker leads between COM and:
3.2 to 6.5 ohms	4 ohms
6.5 to 13 ohms	8 ohms
13 to 26 ohms	16 ohms

STEREO OUTPUT-CONNECTING TO BARRIER STRIPS

Use this table for stereo connections using the barrier strips:

If the speaker impedance is:	Connect one left speaker to screw LEFT-COM and other to:	Connect one right speaker lead to the screw marked RIGHT-COM and the other to:
4 ohms	LEFT-4	RIGHT-4
8 ohms	LEFT-8	RIGHT-8
16 ohms	LEFT-16	RIGHT-16

For 25 volt line operation connect one of the left leads to the screw marked COM on the LEFT OUTPUT barrier strip. The other left lead is connected to the screw marked 8 on the LEFT OUTPUT barrier strip. Connect the right leads in the same manner on the RIGHT OUTPUT barrier strip.

When connected as above the MC 2100 operates as a 105 watt per channel stereo amplifier.

MONOPHONIC OUTPUT—CONNECTING TO BARRIER STRIPS

When the NIC 2100 is to operate as a monophonic amplifier, the two channels are combined to produce a single 210 watt output. This chart lists the proper connections and interconnections for monophonic operation.

If the speaker impedance is:	Connect one speaker lead to the screw marked LEFT-COM and the other to:	Connect a wire between:
2 ohms	LEFT-4	LEFT-4 and RIGHT-4
4 ohms	LEFT-8	LEFT-8 and RIGHT-8
8 ohms	LEFT-16	LEFT-16 and RIGHT-16
For constant voltage		
25 volts	LEFT-8	LEFT-8 and RIGHT-8

When connected as above the MC 2100 operates as a 210 watt per channel monophonic amplifier.

STEREO OUTPUT—CONNECTING TO THE OCTAL SOCKET

The octal socket marked OUTPUT can be used for all of the output impedances and voltages. Connections are made in the following fashion:

If the impedance is:	Solder the left channel leads between:	Solder the right Channel leads between:
4 ohms	Pin 1 and 2	Pin 5 and 6
8 ohms	Pin 1 and 3	Pin 5 and 7
16 ohms	Pin 1 and 4	Pin 5 and 8
For constant voltage		
25 volts	Pin 1 and 3	Pin 5 and 7

When connected as outlined the MC 2100 operates as a 105 watt per channel stereo amplifier.

MONOPHONIC OUTPUT—CONNECTING TO THE OCTAL SOCKET

If the impedance is:	CONNECT	Solder the leads to:
2 ohms	2 and 6	1 and 2
4 ohms	3 and 7	1 and 3
8 ohms	4 and 8	1 and 4
25 volts	4 and 8	1 and 4

When connected as outlined the MC 2100 operates as a 210 watt monophonic amplifier.

AC POWER:

The power requirement for the MC2100 is 117 to 130 volt, 50/60 Hz. The amplifier will be turned on and off if its power cord is plugged in one of the auxiliary AC power outlets on the program source.

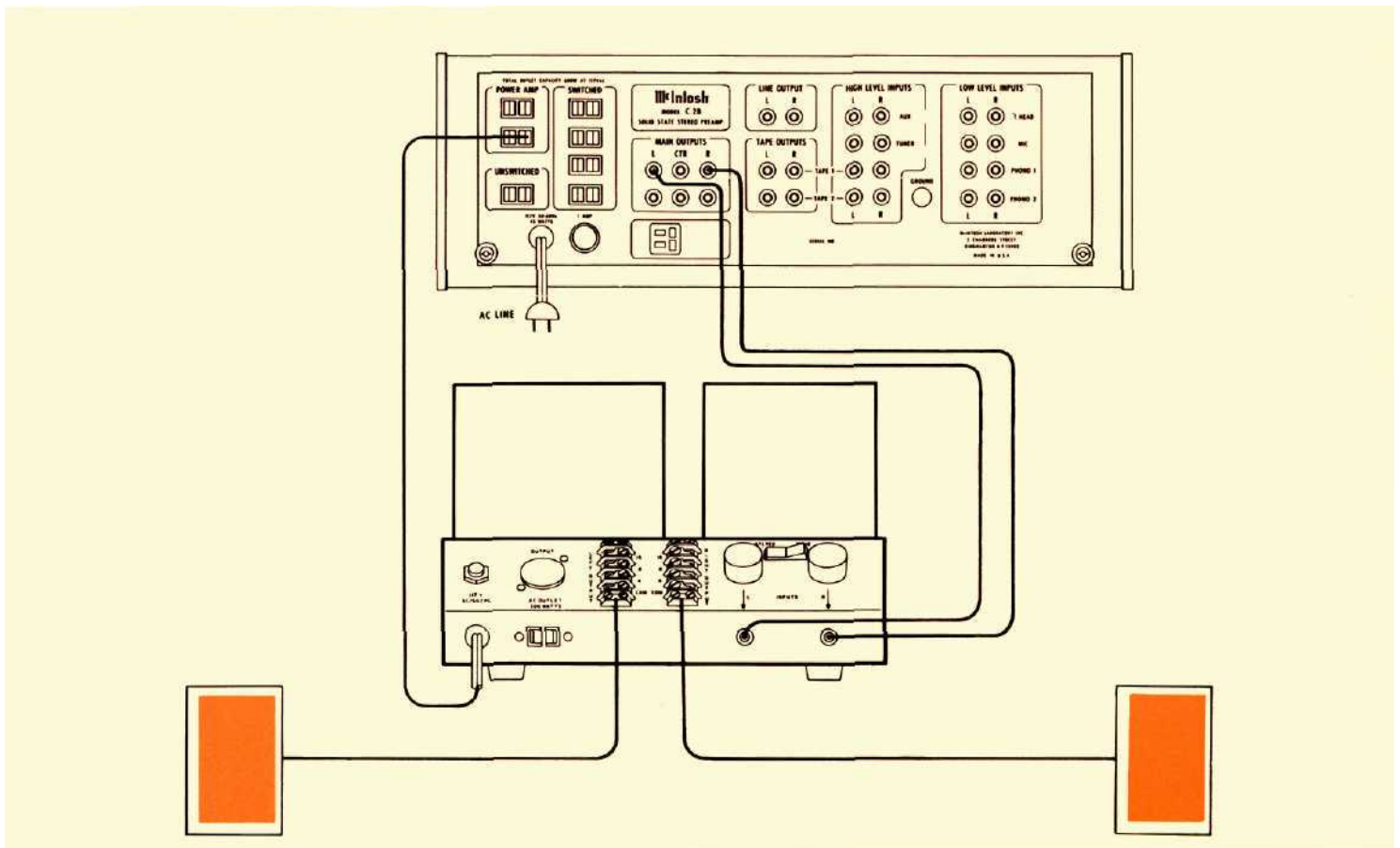

CONTROL PANEL INFORMATION

INPUT

The input of the MC 2100 has a two position switch to permit the amplifier to be used in any one of three ways:

- (1) As a monophonic 210 watt amplifier.
- (2) As twin 105 watt amplifiers used with an electronic crossover network, or as two completely separate amplifiers.
- (3) As a stereo amplifier used with a McIntosh pre-amplifier or other high output stereo program sources.

In either position of the input switch the input sensitivity is 0.5 volts for full rated output. The input impedance is 200,000 ohms.

In the STEREO position each input is controlled by a GAIN control. The GAIN control allows signal sources of 0.5 volt up to 30 volts to be connected without overloading the input to the amplifier.

The MONO position of the input switch parallels the inputs of both amplifiers. When the outputs are properly connected the MC 2100 becomes a 210 watt monophonic amplifier. The RIGHT/MONO GAIN control permits connecting signal sources up to 30 volts without overloading the amplifier's input. To operate the MC 2100 as a 210 watt monophonic amplifier the INPUT switch must be in the MONO position and the OUTPUT must be properly connected for monophonic operation.

OUTPUT

The two barrier terminal strips marked LEFT OUTPUT and RIGHT OUTPUT provide stereo connections for the normal speaker impedances of 4 ohms, 8 ohms, and 16 ohms, or monophonic operation connections for 2 ohms, 4 ohms, and 8 ohms. The terminal strips may also be connected for a constant voltage output of 25 volts in either stereo or mono.

OUTPUT (Octal Socket)

The octal socket marked OUTPUT has stereo connections for 4 ohms, 8 ohms, 16 ohms, and 25 volts. For monophonic operation the octal socket provides connections for 2 ohms, 4 ohms, 8 ohms, and 25 volts.

FUSE

The MC 2100 uses a 5 ampere slo-blo type fuse. The auxiliary AC outlet is not fused.

AC OUTLET

The auxiliary AC outlet can be used to supply power to other equipment in the system. The outlet will provide a maximum of 300 watts of power. The AC outlet is not fused.

LINE VOLTAGE

The MC 2100 operates on any line voltage between 117 volts and 130 volts, 50 to 60 Hz.

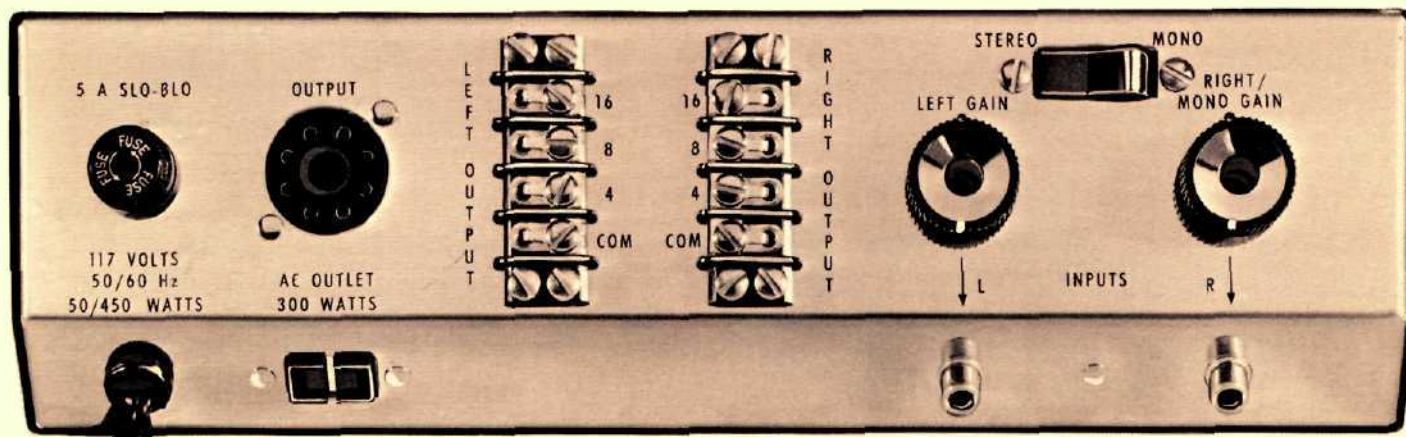

LISTENING TO YOUR STEREO SYSTEM

SETTING THE GAIN CONTROLS:

To set the GAIN controls for a stereo system use a monophonic signal from the program source. A monophonic signal supplies the same voltage to both channels. Turn the volume control on the source equipment to the 12 o'clock position (half rotation).

Turn up the LEFT GAIN control until the loudness

in the room is about as loud as you like to listen. Then turn the GAIN control on the RIGHT INPUT until it is equally as loud as the left channel. The system is now balanced for loudness and provides the greatest range of operation and loudness change when using the volume control on the source equipment.

NOW SIT BACK AND ENJOY YOUR McIntOSH

PERFORMANCE LIMITS

Performance Limits are the maximum deviation from perfection permitted for a McIntosh instrument. We promise you that the MC 2100 you buy must be capable of performance at or exceeding these limits or you get your money back. McIntosh is the only manufacturer that makes this guarantee.

POWER OUTPUT

STEREO: 105 watts continuous, per channel, both channels operating, which is:

20.5 volts RMS across 4 ohms

29.0 volts RMS across 8 ohms

41.0 volts RMS across 16 ohms

MONO—210 watts continuous, which is:

20.5 volts RMS across 2 ohms

29.0 volts RMS across 4 ohms

41.0 volts RMS across 8 ohms

HARMONIC DISTORTION

STEREO Will not exceed 0.25% at any power level to 105 watts output per channel from 20 Hz to 20,000 Hz both channels operating. Typical performance is less than 0.1% at rated power. Distortion decreases as output power is reduced

MONO Will not exceed 0.25% at any power level to 210 watts output from 20 Hz to 20,000 Hz. Typical performance is less than 0.1% at rated power. Distortion decreases as output power is reduced

INTERMODULATION DISTORTION

STEREO Will not exceed 0.25% if instantaneous peak power is 210 watts or less per channel with both channels operating for any combination of frequencies 20 Hz to 20,000 Hz

MONO Will not exceed 0.25% if instantaneous peak power is 420 watts or less for any combination of frequencies 20 Hz to 20,000 Hz

FREQUENCY RESPONSE

20 Hz to 20,000 Hz +0 -0.25 dB at rated power

15 Hz to 60,000 Hz +0 —0.5 dB at rated power

10 Hz to 100,000 Hz +0 -3.0 dB at one-half rated power

NOISE AND HUM

90 dB or more below rated output

OUTPUT IMPEDANCE

STEREO 4, 8, and 16 ohms

MONO 2, 4, and 8 ohms

OUTPUT VOLTAGES

25 volts STEREO and MONO

DAMPING FACTOR

20 at 4 ohms output

14 at 8 ohms output

11 at 16 ohms output

INPUT IMPEDANCE

200,000 ohms

INPUT SENSITIVITY

0.5 volt. Level control provided for higher input voltage

POWER REQUIREMENTS

120 volts 50/60 Hz, 50 watts at zero signal output

450 watts at rated output

SEMICONDUCTOR COMPLEMENT

32 silicon transistors

14 silicon rectifiers and diodes

MECHANICAL INFORMATION

SIZE: 7% inches high (19.69 cm), 11% inches wide (29.85 cm), 17 inches deep (43.18 cm)

CHASSIS: Chrome and black.

WEIGHT: 57 pounds (25.86 kg) net, 63 pounds (28.58 kg) in shipping carton

SPECIAL FEATURES

The amplifier is completely stable when connected to any loudspeaker system or even to any reactive loads. The MC 2100 has special circuits to prevent damage by short circuit or open circuit of the output loads, or by any amount of output impedance mismatch.

Thermal cutouts are mounted on the output transistor heat sinks to provide protection in the event of inadequate ventilation.

PERFORMANCE CHARTS

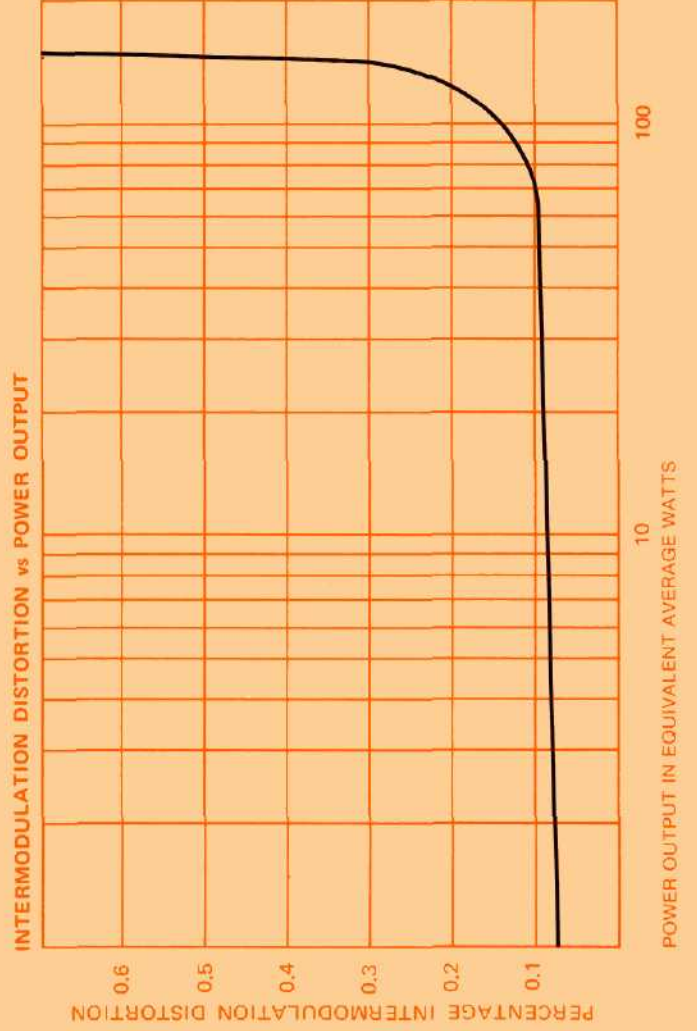
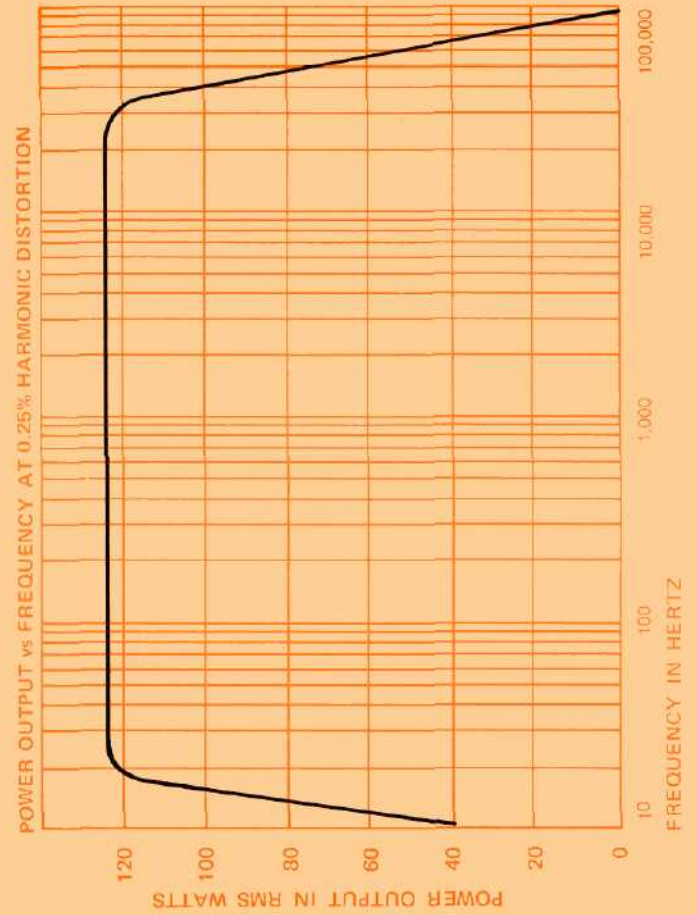
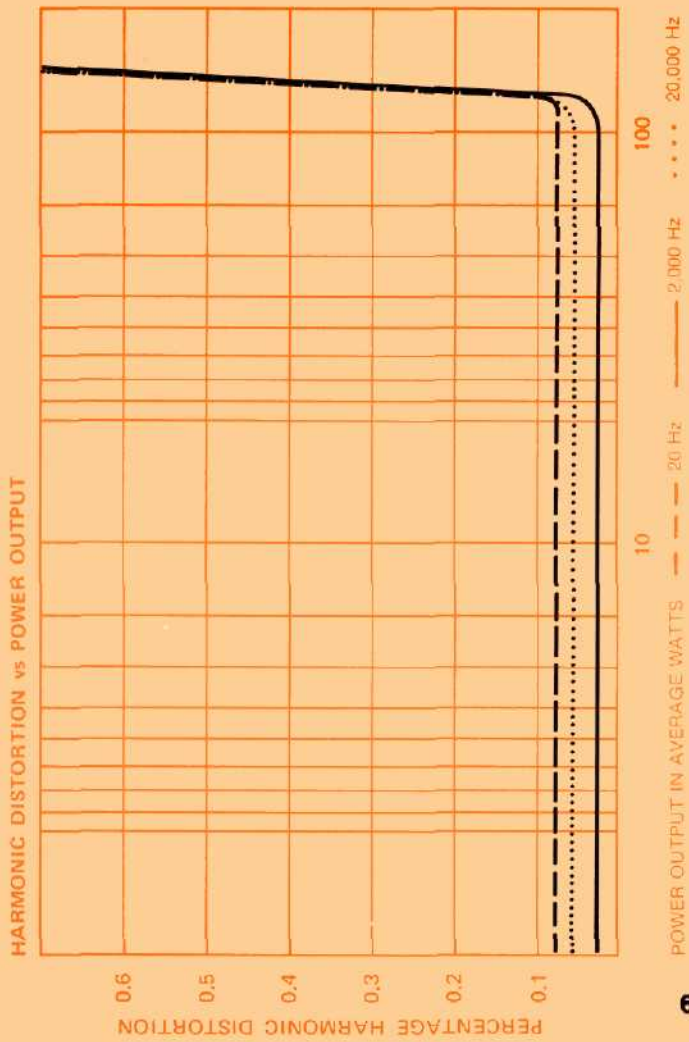

TECHNICAL DESCRIPTION

A two stage preamplifier with three transistors in each channel increases the input voltage 16 dB.

There are 13 transistors in each power amplifier section. The two stage preamplifier is fed to a pair of matched transistors arranged as an emitter coupled amplifier with two inputs and one output. The signal from the preamplifier section connects to one of these inputs. Both AC and DC negative feedback are applied to the other input. This large quantity of feedback is used to reduce noise and distortion. The signal is then fed to a voltage amplifier. The voltage amplifier is followed by two driver transistors.

The output section is arranged as a series push-pull amplifier. The power transistors used in the output section of your MC 2100 are selected for their high power dissipation capability, wide frequency response, and large "safe operating area." In addition, each power transistor is given four separate tests before it is put in your MC 2100. This additional testing makes sure your MC 2100 will deliver its rated power from 20 Hz to 20 kHz with low distortion and complete reliability.

The power transistors are mounted on oversized anodized heat sinks. The heat sinks assure that under normal operation the transistors will operate at a low temperature. If temperatures increase due to a shorted speaker, or restricted ventilation, an automatic temperature sensing device turns off the MC 2100. The device operates automatically at a preset temperature. The MC 2100 will turn on again when the temperature has returned to normal limits. This additional feature gives your MC 2100 complete reliability under the most extreme operating conditions.

The output stages are matched to the load by the McIntosh autoformer. The McIntosh autoformer is carefully wound using McIntosh trifilar winding and interleaving techniques. Trifilar winding and interleaving gives the autoformers exceptional bandwidth. The autoformers properly match the power transistors to 4, 8, and 16 ohm loads at all audio frequencies.

The use of the McIntosh designed trifilar autoformer makes the McIntosh solid state amplifiers the only amplifiers that deliver **FULL POWER AT ALL SPEAKER IMPEDANCES**. You have not been power penalized for your choice of loudspeakers when using the McIntosh MC 2100.

Another of the advantages of the autoformers is the 25 volt output for a constant voltage distribution system. With the MC 2100 several sets of speakers can be operated independently throughout your home.

To further insure reliability a special power output SENTRY MONITORING CIRCUIT prevents failure of the power output transistors due to excessive mis-

match of the output. When your MC 2100 operates normally the SENTRY MONITORING CIRCUIT has no effect on signals passing through the power amplifier. If the power dissipation should rise above normal operation, the SENTRY MONITORING CIRCUIT restricts the drive to the output transistors. The SENTRY MONITORING CIRCUIT acts instantaneously for any input signal or load combination. This arrangement assures complete circuit reliability. Only McIntosh gives you this degree of protection.

There are three separate power supply sections. One positive and one negative high current supply is used for the output stages. The other positive supply is used for the driving amplifier stages. All supplies are full wave and use silicon rectifiers. Adequate filtering is used to assure an absolute minimum of hum. The power output stage filter capacitors have very high capacity, which allows full power output below 20 Hz. The power transformer is generous in size and runs cool, even under heavy use.

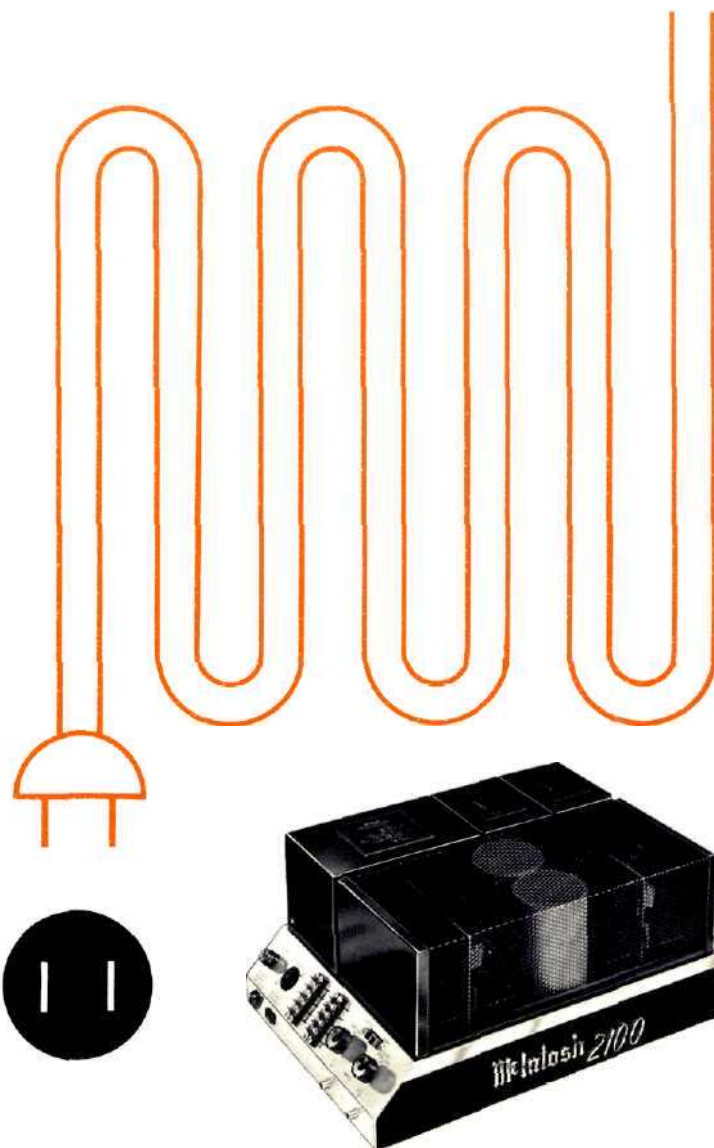

Block Diagram

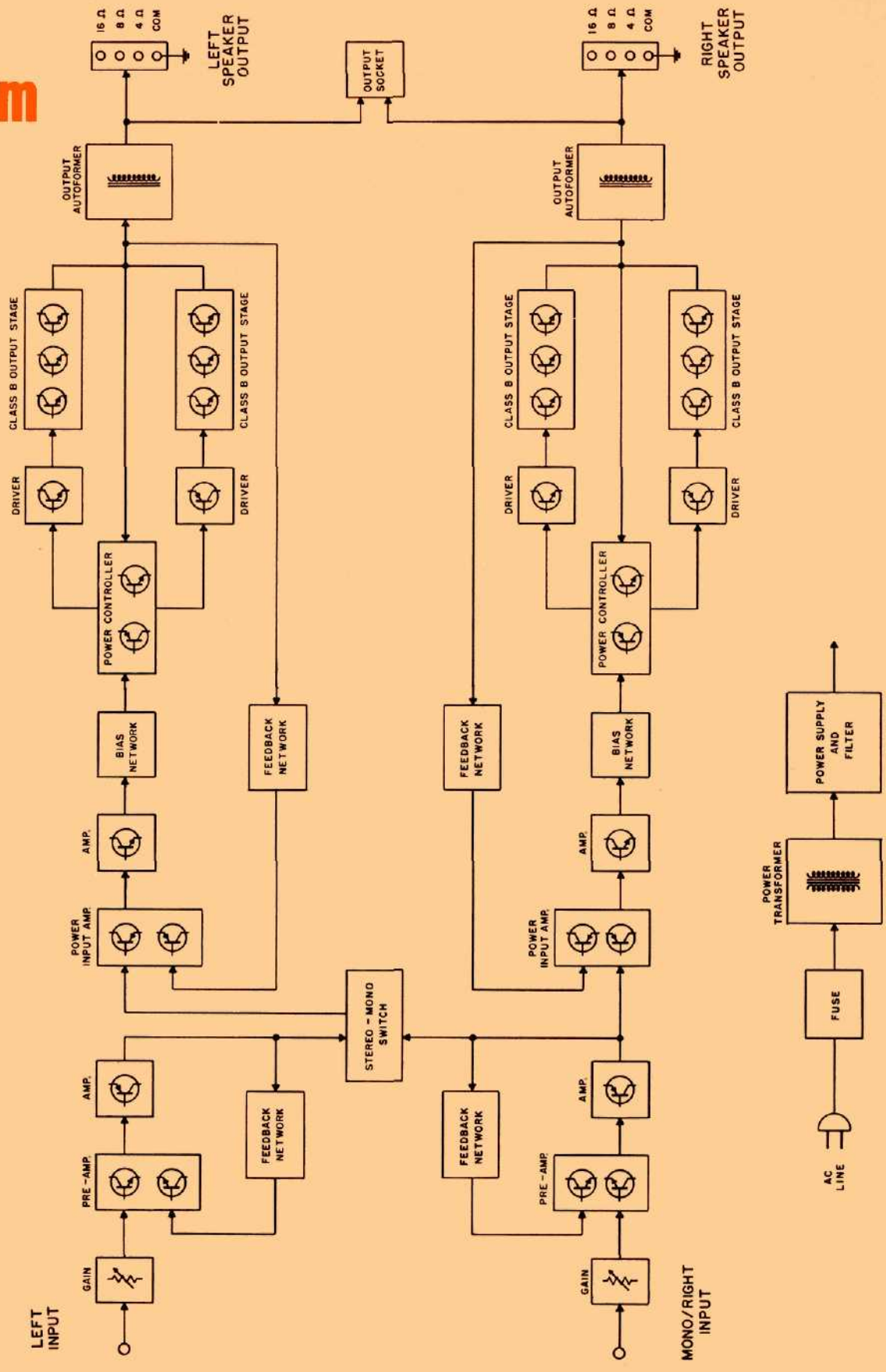

McIntosh

McINTOSH LABORATORY INC.

2 CHAMBERS ST., BINGHAMTON, N. Y. 13903

607-723-3512

Design subject to change without notice.

Printed in U.S.A.

038-663